



AUTOMATION SERIES CATALOG

**AUTOMATION  
SERIES**

## Five Day Lead Time



» Belts marked with the Quick Ship icon (QS) are available with just a five day lead time.



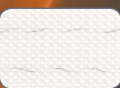

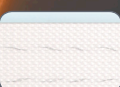
## Flat Belt Material Options



- 

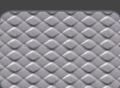

**MAA** — Multipurpose Belt  
**Surface:** Smooth, White Urethane  
**FDA Approved:** Yes
- 

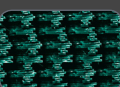

**MAB** — Multipurpose Belt  
**Surface:** Smooth, Sealed Edge Urethane  
**FDA Approved:** Yes
- 



**MAE** — Multipurpose Belt  
**Surface:** Smooth, White Urethane  
**FDA Approved:** Yes
- 

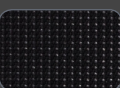

**FAA\*** — High Friction Belt  
**Surface:** Snakeskin, Grey PVC  
**FDA Approved:** No
- 



**FAF** — High Friction Belt  
**Surface:** Rough Top, Green PVC  
**FDA Approved:** No
- 

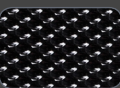

**AAA** — Accumulation Belt  
**Surface:** Fabric, Urethane Impregnated  
**FDA Approved:** Yes
- 

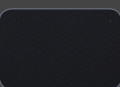

**AAC** — Accumulation Belt  
**Surface:** Fabric, Black Urethane  
**FDA Approved:** No
- 

**IAF** — Cut Resistant Belt  
**Surface:** Dimple Top, Black PVC  
**FDA Approved:** No
- 

**IAC** — Cut Resistant Belt  
**Surface:** Dimple Top, Black Urethane  
**FDA Approved:** No
- 

**EAC** — Static Conductive Belt  
**Surface:** Smooth, Urethane  
**FDA Approved:** No
- 

**PAD** — Color Contrasting Belt  
**Surface:** Smooth, Urethane  
**FDA Approved:** Yes
- 

**TAA** — Translucent Belt  
**Surface:** Textured, Urethane Impregnated  
**FDA Approved:** Yes
- 

**RAE** — Release Properties Belt  
**Surface:** Smooth, White Silicone  
**FDA Approved:** Yes

## Optional V-Guide Belts

All conveyors support V-Guide belting with no additional parts. These belts are ideal for side loading applications where belt tracking might otherwise be difficult to maintain.

\*Indicates belts not available for use with AS40-CD Conveyors  
 More belt options available at [qcconfig.com](http://qcconfig.com)  
 Consult factory for Heat Resistant and Profile/Specialty Belts

## Tension Release Tail™

- » Operates at the push of a button to relieve tension on the belt
- » Cleaning under the belt is quick and easy, with no tension or tracking adjustments required
- » Tracks easily with set screws in the tail that maintain tracking through multiple tension release cycles

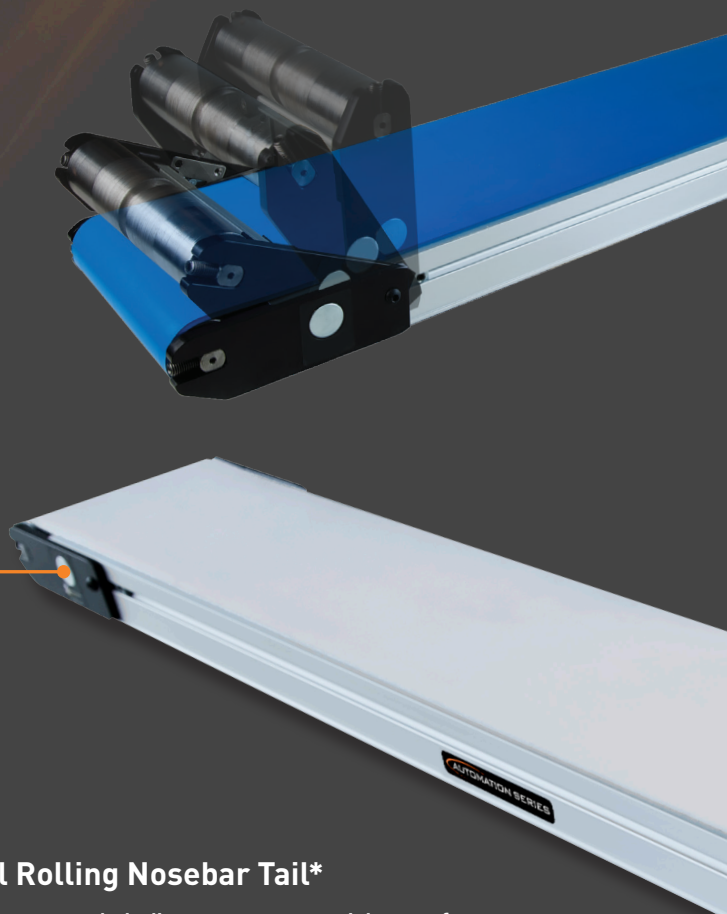

## Optional Rolling Nosebar Tail\*

- » Thin, 11 mm outer belt diameter ensures a tight transfer for small parts
- » Available for all standard width conveyors
- » Drop-in Nosebar Tension Release Tail idlers facilitate easy modification of existing conveyors
- » May be used for pushing and pulling applications



## High Speeds

Speeds up to 400 FPM make AS40-ED and AS40-CD Conveyors ideally suited for high-speed automation and assembly lines

\*Rolling Nosebar Tail reduces load carrying capacity and max speed

# Designed with You in Mind

QC Conveyors' Automation Series Conveyors are the ultimate user-friendly conveyor. High tech features like Tension Release tails, Pivot rotatable drives and movable center drives were designed to make your job easier.

## Rigid Aluminum Frame

- » Single piece extruded aluminum frame for conveyors up to 12" wide
- » Strong multi-piece aluminum and steel frame for conveyors over 12" wide
- » Frames designed to reduce both lateral and longitudinal deflections
- » Built in Tee Slots for easy stand and accessory mounting with drop in nuts

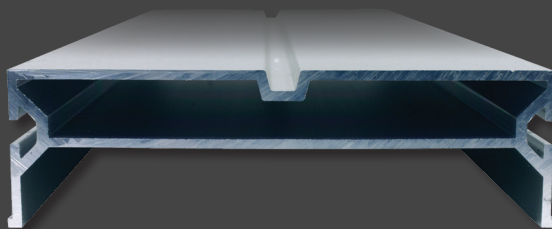

## Built-to-last Bearings

Sealed, 35 mm, double row ball bearings handle high speeds, and provide extended bearing life (drive only)

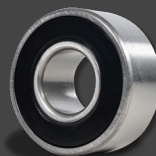

## Drive Pulley

- » Straight knurl design prevents premature belt wear
- » Crowned pulley promotes proper belt tracking

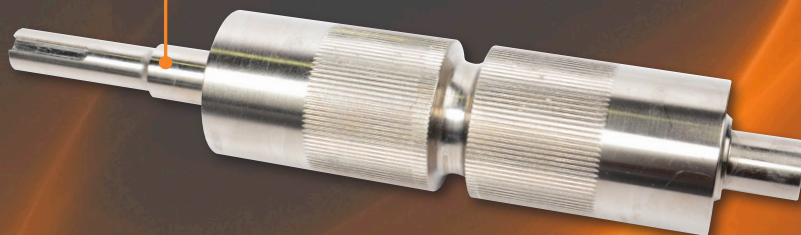



# AS40-ED End Drive Conveyors

End Drive conveyors are ideal for almost any application with a wide variety of drive packages available.

They offer high power at a great value.

## Pivot™ Rotatable Drive

- » Flexibility to move the drive out of the way as your application requirements change, all while the conveyor is installed
- » Rotate the drive by loosening a screw, moving the drive to the desired position to clear machine obstacles or product on the belt
- » When positioned below the conveyor, the belt is the highest point

## Cleated Belts & Corrugated Sidewall

Cleated belts available for positive part movement in incline and decline applications. Corrugated sidewalls are optional to keep small parts on the conveyor and can be used with cleats to create a bounded pocket

Code	WAB	WAE	WAG	WAI	WAK
Cleat Height	5mm	½ in	1 in	2 in	3 in

## Specifications

- » Widths: 2", 3", 4", 5", 6", 8", 10", 12", 18" 21", 24"
- » Lengths: Up to 20'
- » Loads: up to 120 lbs.
- » Speeds: up to 400 FPM
- » Profile: 1.95" High
- » Assembled with all metric fasteners

## Backlight Conveyors

- » Backlights are used in a wide variety of machine vision applications to provide contrast for part inspection or robot orientation. The contrast from the backlight allows for better resolution from the vision system than reflective lighting can provide.



# AS40-CD Center Drive Conveyors

Center Drive conveyors are ideal for applications where both ends must be clear. Center drive idler pulleys are easily removed for rapid belt changes without removing the drive.

## Movable Center Drive

Center Drive can be placed at any point along the length of the conveyor – simply loosen a few screws, slide to new location and re-tighten

## Rolling Nosebar Tail

» Rolling Nosebar Tails can be applied to both ends of the conveyor for tight transfers.

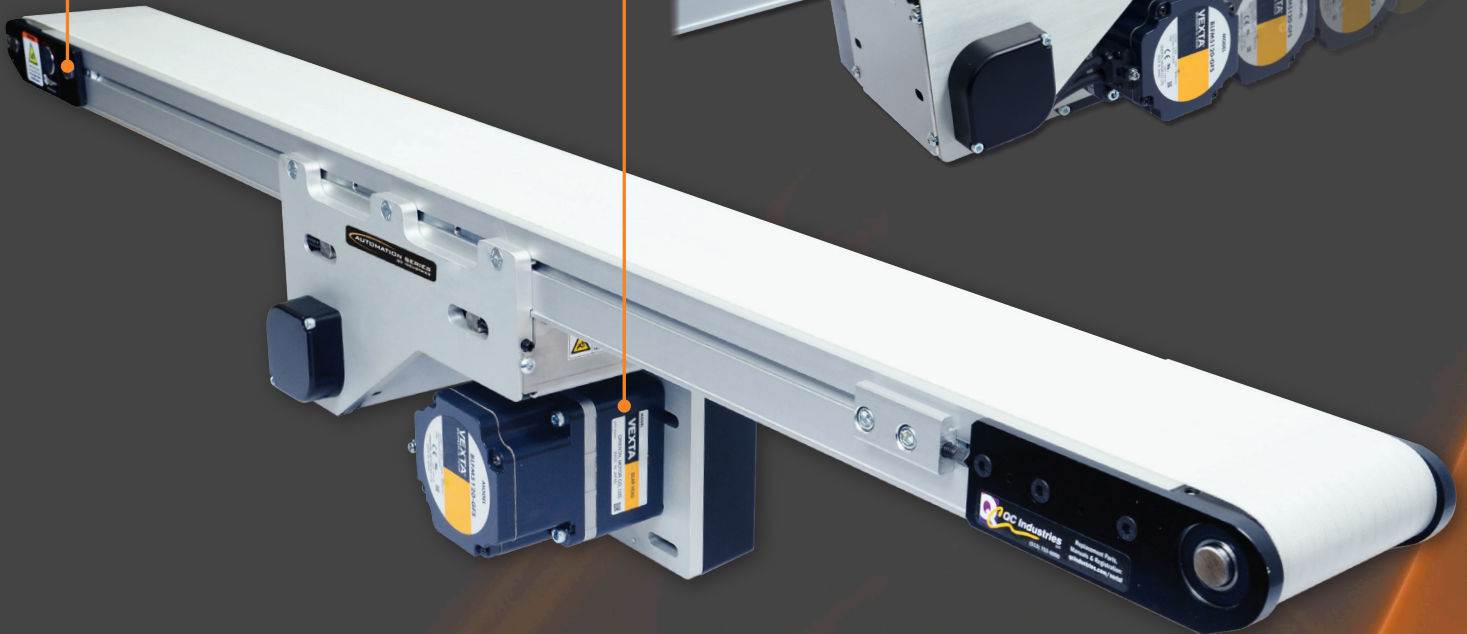

## Specifications

- » Widths: 2", 3", 4", 5", 6", 8", 10", 12", 18", 21", 24"
- » Lengths Up to 26'
- » Loads: up to 120 lbs.
- » Speeds: up to 400 FPM
- » Profile: 1.95" High
- » Assembled with all metric fasteners

# AS40-Z Angled Frame Conveyors

Three configurations make AS40-Z Conveyors ideal for any elevating or lowering application. They feature a rigid aluminum or aluminum/steel frame, just like our AS40-ED and AS40-CD conveyors.

## Z-Track™ Design

Z-Track design gives you control over belt tracking, even through belt changes



## 3 Standard Angles Available\*



## Specifications

- » Widths: 8", 10", 12", 18", 21", 24"
- » Lengths: up to 20'
- » Loads: up to 120 lbs
- » Speeds: up to 200 FPM
- » Frame Profile: 1.95"
- » Standard Angles: 30°, 45°, 60°\*

\*Additional angles available by factory quote

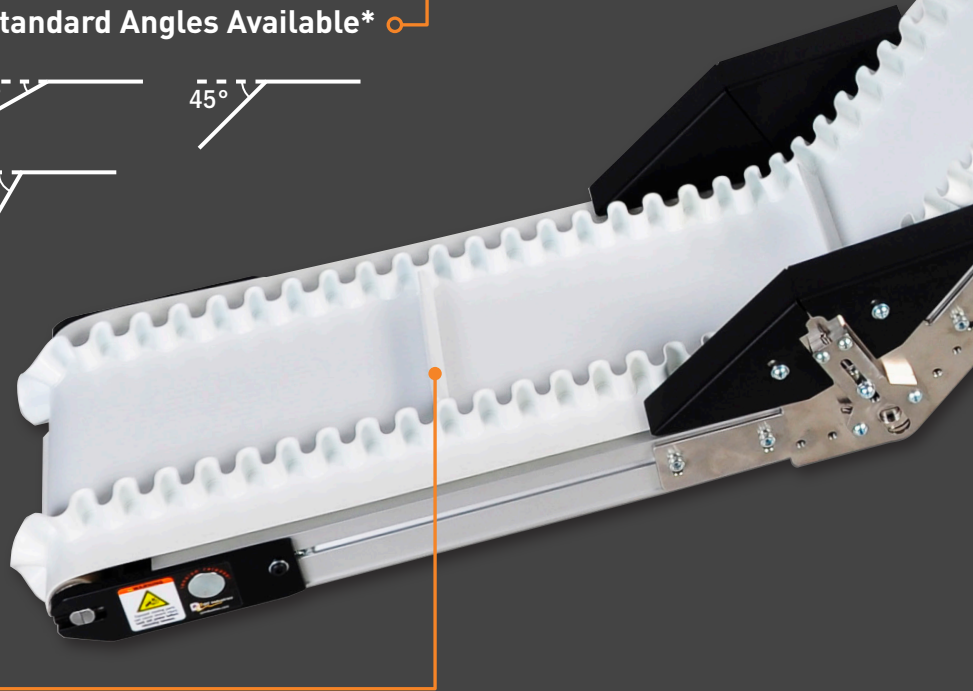

## Cleated Belts

Cleated belts available for positive part movement in incline and decline applications

						
Code	ZAB	ZAE	ZAG	ZAI	ZAK	ZVR
Cleat Height	5mm	½ in	1 in	2 in	3 in	1 in



### Corrugated Sidewall Belt

Corrugated sidewall belts are available for containing small parts; comes with a 1 inch cleat

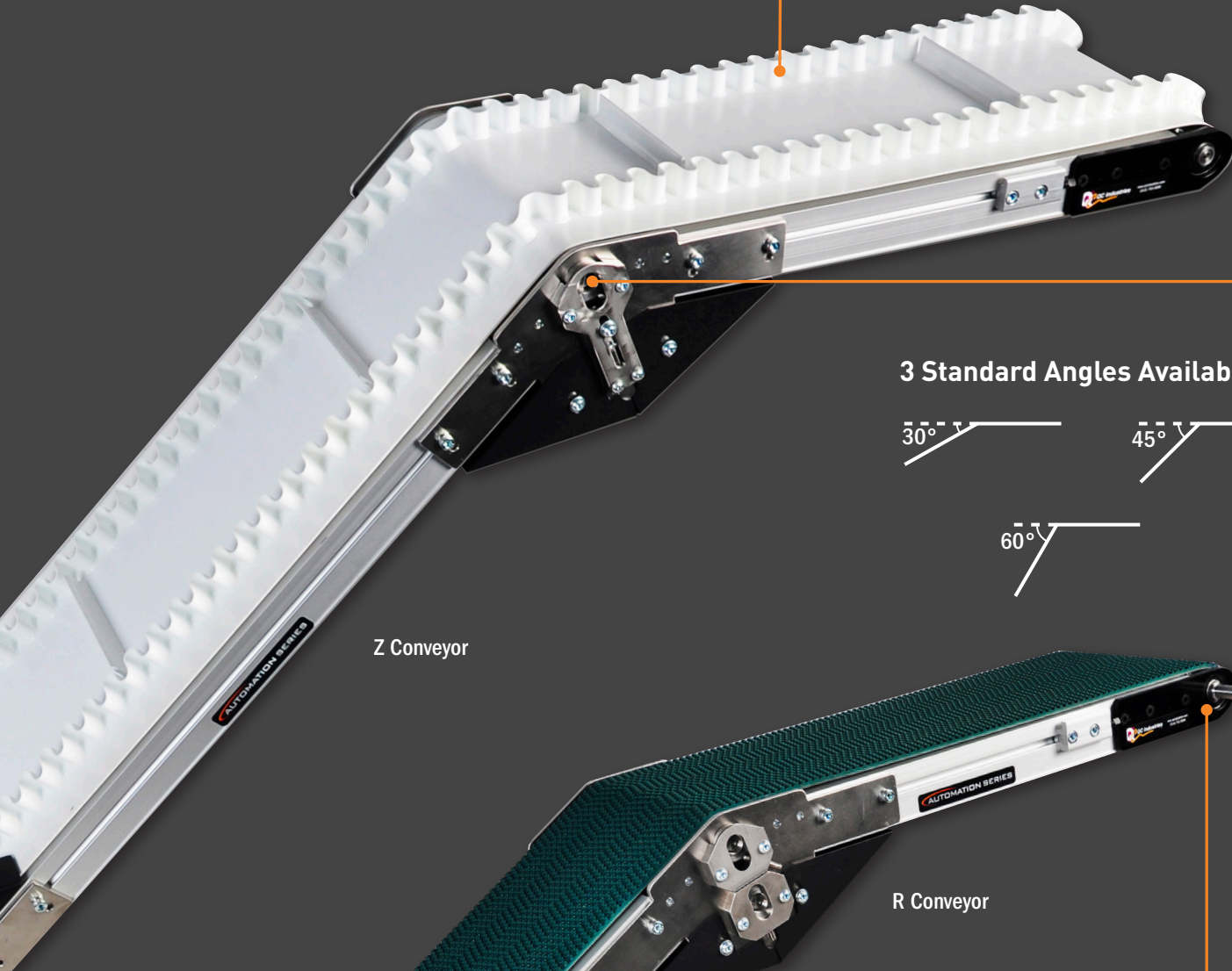

Z Conveyor

### 3 Standard Angles Available\*



R Conveyor

### Built-to-last Bearings

Sealed, 35 mm, double row ball bearings handle high speeds, and provide extended bearing life (drive only)

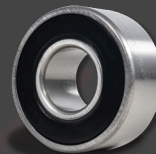

Only R configuration can be used with non-cleated standard belts.



# Gearmotor Mounting Packages

## Pivot™ Drives

Pivot™ drive mounting allows the drive to be easily rotated to different positions for maximum flexibility.



## AS40-CD Center Drive

Center Drive mounting places the gearmotor below the conveyor and can be positioned anywhere along the conveyor frame.



## Inline Side Drives

Inline Side Drive mounting allows drive to be mounted on either side of the conveyor, parallel to the drive pulley.

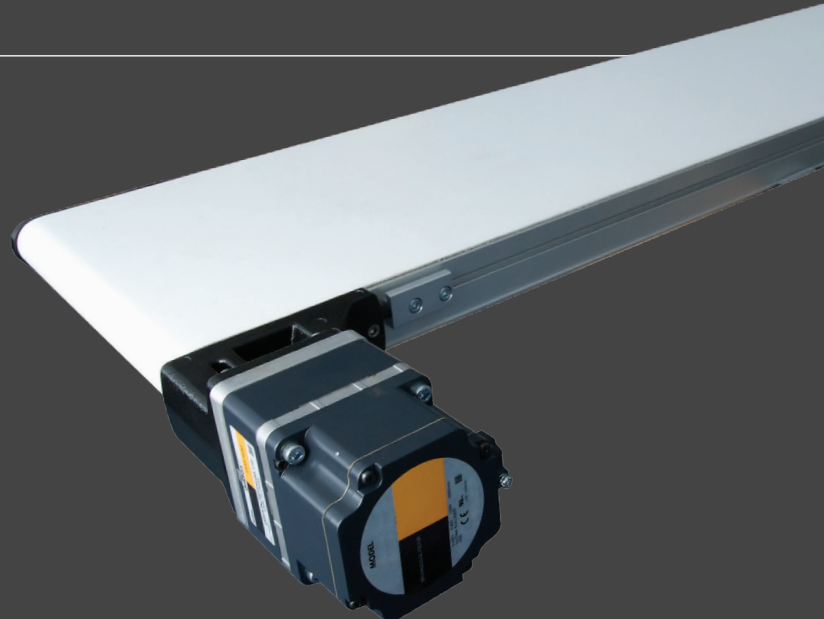

## Right Angle Side Drives

Right angle side drive mounting allows Heavy Duty Drives to be positioned parallel to the conveyor frame to fit tight space constraints. For use with 56C face gearmotors.

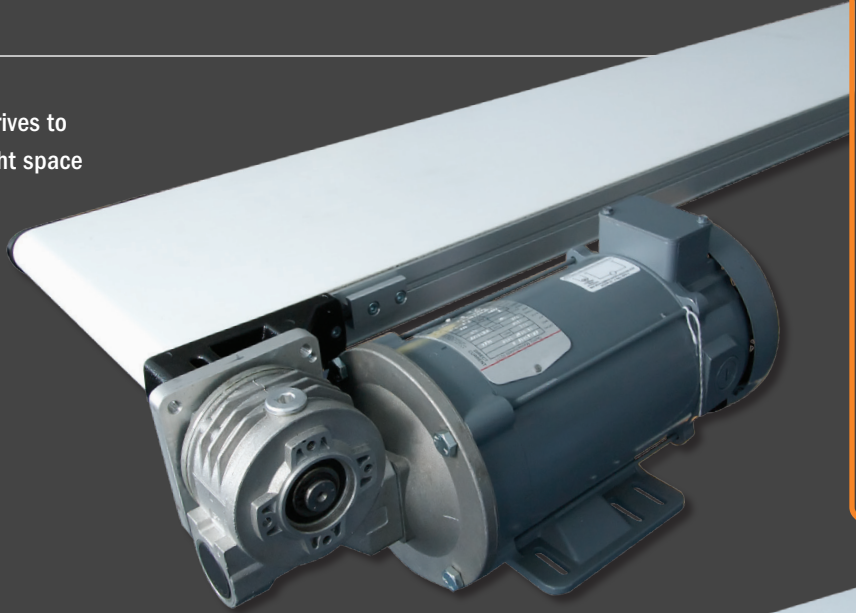

## Top/Bottom Drives

Top and Bottom drive mounting allows Heavy Duty Drives to be positioned above or below the conveyor. For use with 56C face gearmotors.

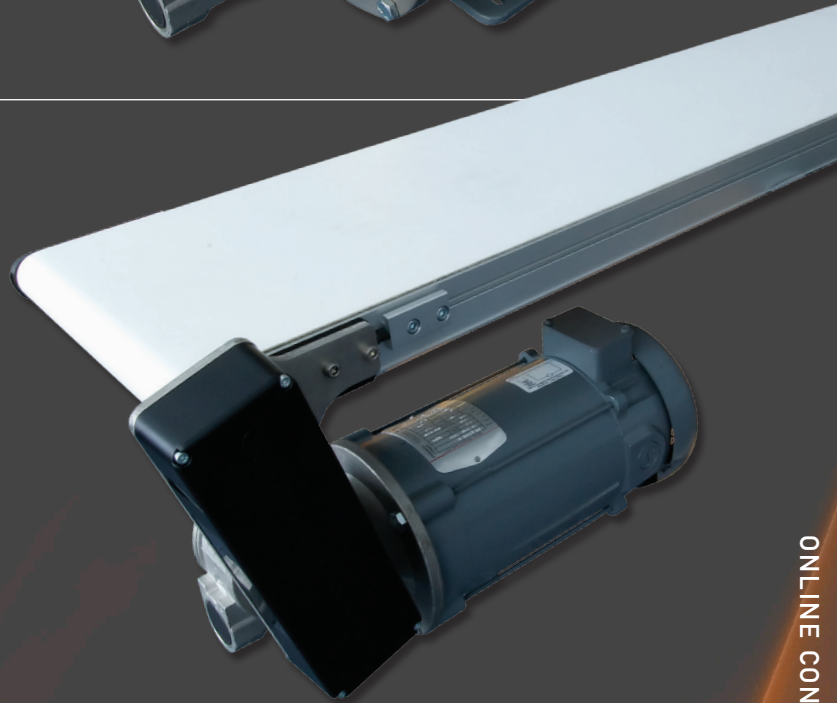

## Drive Locations Chart

For AS40-ED Conveyors, right and left are defined when the conveyor is viewed from the drive pulley end. For AS40-CD Conveyors, they are defined from the discharge end.



# Gearmotors

## Standard Duty Fixed and Variable Speed Gearmotors

### Specifications/Features

- » Available in 40 Watt, 90 Watt and 200 Watt
- » 115V & 230V Single Phase, and 230V Three Phase
- » 40 Watt Variable Speed Electric Gearmotor available with housed controller attached alongside the gearmotor (shown below)
- » NEMA 4X controller can be used to achieve variable speed capabilities

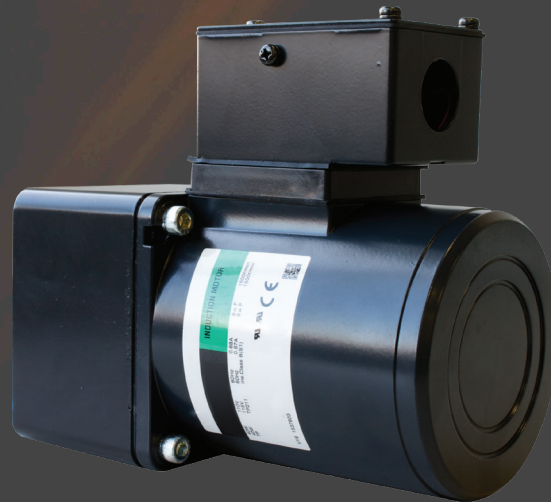

## Heavy Duty Fixed and Variable Speed Gearmotors

### Specifications/Features

- » Available in 115V & 230V Single Phase, 230V & 460V Three Phase, and 90V DC
- » Optional Controllers available for both AC and DC Heavy Duty Gearmotors



## Brushless DC Gearmotor & Control

With its integrated DC controller, the Brushless DC gearmotor offers the greatest range of speed adjustment of any of our gearmotors. The controller features a built-in speed potentiometer to allow for easy adjustment, or it can be set for specific speeds. It also integrates with outside control systems for automated operation. A 3m (10 ft) cable is included for connecting to the gearmotor.

### Control Specifications/Features:

- » 50:1 speed range
- » UL/ULc/CE
- » IP20 Protection Rating
- » Three speed display modes
- » Multi-speed operation using up to eight different speeds

### Gearmotor Specifications/Features

- » Available in 120, 200, and 400 Watt
- » Available for 115V Single Phase, 230V Single Phase, and 230V Three Phase.
- » Variable Speeds: 1- 225 FPM

Note: 400 Watt Gearmotor is only available in 230V Three Phase.



To find gearmotor and mounting package part numbers, please visit the Conveyor Configurator – [qcconfig.com](http://qcconfig.com).

Note: It is the responsibility of the end user to properly wire controllers and gearmotor starters to the gearmotor.



## Aluminum Stands

Our aluminum stands feature an all-new design that is easier to install and adjust. They provide an economical option for supporting any size conveyor.

- » Brackets attach directly to tee slot and mount to stand base for easy installation
- » An internal adjustment mechanism provides positive engagement at all times, making adjustments safe and simple
- » Cross ties are easy to adjust to the proper length with no cutting required



## Angle Braces

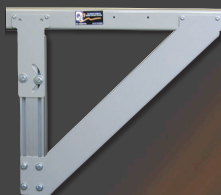

For use with aluminum stands.  
Note: When used with casters, angle braces must be used on both stands. Angle brace cannot be used on inclines or declines.

## Casters



Order two per stand.  
Swivel locking casters should only be used with stands that are 1/3 as wide as they are tall.

## Drop In Tee Nuts



Can be inserted into Tee Slots on conveyor stands.  
M6 thread.

# Guides, Sides & Mounts

## 2-Axis Adjustable Guides

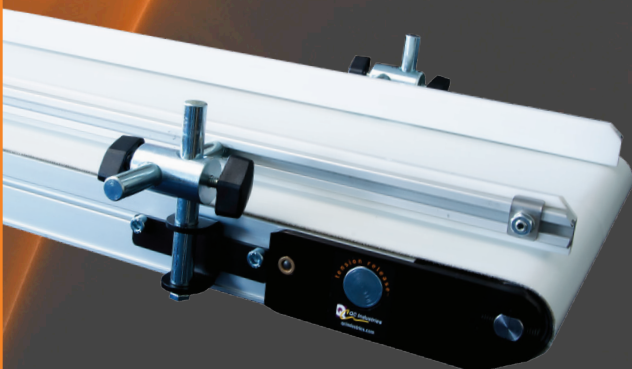

Adjustable side rails offer the ultimate in flexibility. Available guide heights are 1" (shown), 2", and 3". Standard guides may be adjusted approximately 3" vertically and horizontally. These guides are available with optional thumb screws (shown) for tool-less adjustments.

Additional adjustment lengths available by factory quote.

## Fixed Side Rails



Side rails can be used to contain and guide product on the conveyor. They are available in 1/3", 1" (shown) and 2". Wear strips to protect the sides and product from scuffs and marks are available.

Not compatible with all belt choices. See [qcconfig.com](http://qcconfig.com) for more information.

## Flush Side Mount

Can be attached at any point along the conveyor to mount the frame flush to a flat surface. Mounts are universal and work on either side of the conveyor. Not compatible with cleats.



## Raised Side Mount

Can be attached at any point along the conveyor to mount the frame to a flat surface. Foot can be placed either inside or outside the conveyor footprint. Mounts are universal and work on either side of the conveyor. These mounts are compatible with any standard cleat height.



# Custom Conveyor Solutions

If you're looking for something a little different than our standard conveyors, we can customize it for you. Whether it's a bracket to integrate with a customized piece of equipment, a drive mount for your gearmotor, or a modification to one of our conveyors to fit your application parameters — give us a call. Below are a few custom solutions we have created.

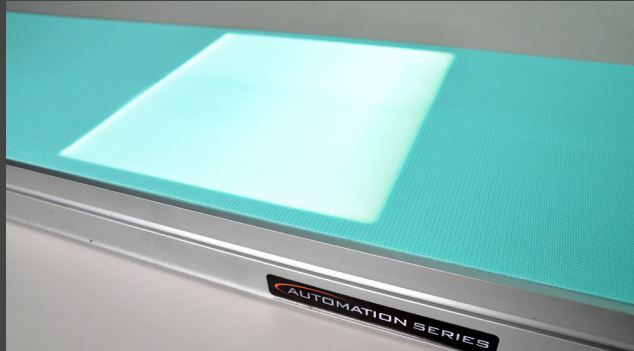

## Backlighting

Our conveyors can be modified to accept a wide variety of customer-specified backlights for vision applications. When coupled with a translucent belt, the conveyor creates an ideal platform for inspection as parts travel past.

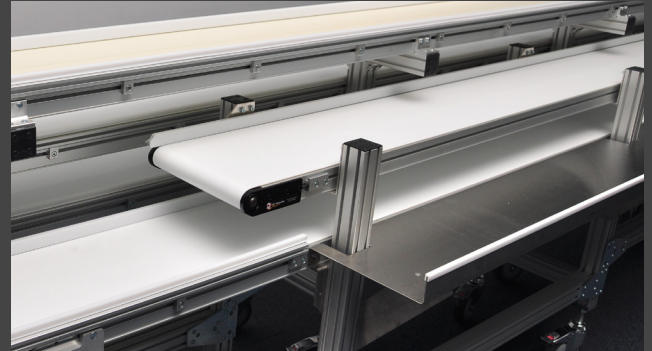

## Custom Stands & Side Tables

We're often asked to design special stands to accommodate each customer's unique requirements. In this pack-off line, candy came in from the wrapping machines and was packed by hand into boxes coming in from the box erector. The filled boxes then left on a third line of conveyors for shrink wrapping. The application required custom stands and stainless steel side tables where operators packed the boxes.



## Multiple Bands

In this application, our customer needed to perform an operation on the bottom of a part as it moved across the conveyor. Our solution involved running two belts on the conveyor with a cutout between them. The part straddled the two belts and a robot performed the operation from below through the cutout.



## Elevator Conveyors

For an application that required product to move across a healthcare packaging plant, we devised an elevator system to elevate the bins to move overhead across the plant. The system consisted of two 300 Series Indexing Conveyors with an InnerDrive Conveyor mounted between them. After bins moved onto the InnerDrive conveyor, the 300 Series conveyors moved in tandem to raise the InnerDrive conveyor, which then moved the bins onto the overhead conveyor system.



# 24/7 Online Quoting

Configure and quote conveyors 24 hours a day using our online Conveyor Configurator. An intelligent assistant uses engineer-developed rules to make sure all your components – including gearmotors, stands, and sides/guides – work together properly.

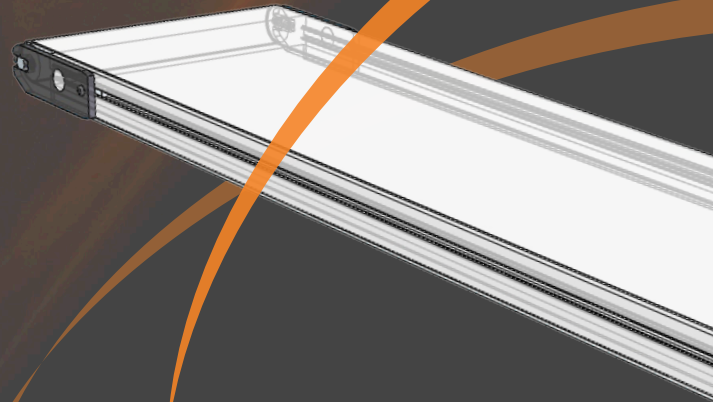

## Conveyor Configurator

Fast, intelligent online configuration and quoting



### Fast, Intelligent, Online

- » Manage multiple conveyors in a single quote using separate bills of materials
- » Our algorithms identify errors and offer options for making corrections
- » Register your conveyor to qualify for our 10 Year Warranty
- » Access appropriate manuals and videos by serial number to make maintenance easy
- » View past orders and quote replacement parts directly from the original bills of materials, complete with exploded views to help you find exactly the right part

### Download 3D CAD Models

Once you've designed a conveyor with the *Conveyor Configurator*, you can download all the 3D CAD models, exploded views and specifications in one package to make integration with your application easy. We've included sides/guides, drives, and stands, so it's easy to drop the complete conveyor system directly into your application.



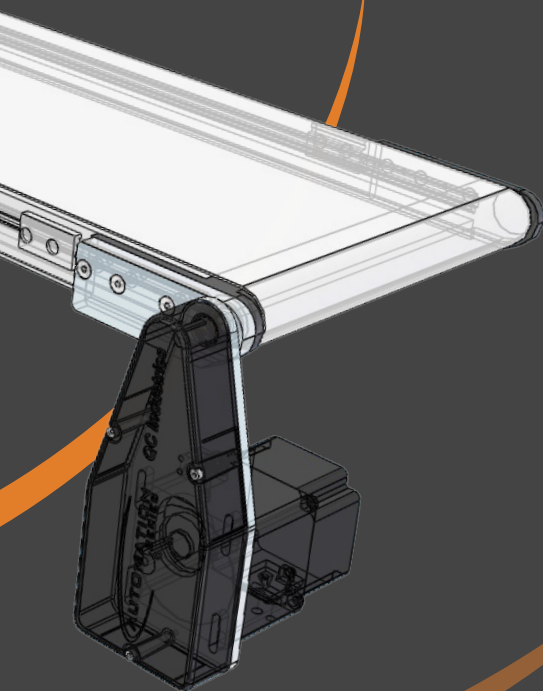

## 10 Year Limited Warranty

Our products are developed and tested with long-term reliability in mind. To ensure our conveyors will run problem-free in the field for many years, we demand the tightest tolerances in the industry and manufacture our components using the most advanced processes available. Each conveyor is inspected at several points of the manufacturing process to ensure quality, including a final operational test before it leaves our facility. That's why we confidently stand behind our products with a 10 year warranty when they're registered at [qcconveyors.com/serial](http://qcconveyors.com/serial).



## 5 Day Lead Times

Many of our most popular conveyors are available with just a five day lead time. Several of our most popular belt options are available for quick shipment. Look for the Quick Ship icon in our Conveyor Configurator to guide your selections and ensure a five day lead time!



## Why QC Conveyors?



For more than 35 years, we've been focused on one thing: providing our customers with reliable, easy to use conveyor systems that meet their needs, then backing them with world class service and support. Whether you're an end user looking to decrease your line's downtime or an OEM putting our conveyor in a machine with your company's name on it, QC Conveyors offers the quality, reliable product you're looking for.

We view our customers as partners, not for a single sale but for the long run. We regularly meet with them to learn how our products can better meet their needs and work hard to incorporate those needs into our products. In addition, we have a dedicated team of customer service professionals ready to assist in any way they can, each empowered with the flexibility to keep customers happy.



We invite you to visit our state of the art headquarters in Cincinnati, Ohio, where you can get your hands on our product and see first hand how easy it is to use and maintain. Once you do, we're confident you'll be a customer for life.



# Learn More

## Additional Products Available from QC Conveyors

In addition to our versatile Automation Series conveyors, we offer a variety of other products. Our **Industrial Series** includes IS125 conveyors built for heavier loads, IS175-ID conveyors with an embedded drive, and IS300 conveyors which feature a timing belt with accuracy to  $\pm 0.15$ ". **HydroClean Series** conveyors are built on a stainless steel platform with a design that makes them easy to clean. Please visit our website or contact your local distributor for more information.



### qcconveyors.com

QC Conveyors' website – [qcconveyors.com](http://qcconveyors.com) – is your resource for the most up-to-date information about all our products.



### Conveyor Configurator

Configure & quote conveyors online, 24 hours a day. See page 14 for more information.



### Your Local Distributor

Contact our sales department today at (513) 753-6000 to find your local distributor.



AUTOMATION SERIES CATALOG



(513) 753-6000 | [qcconveyors.com](http://qcconveyors.com) | Part # MKTG-AUTO-1812



THE DURAVANT FAMILY OF COMPANIES

[www.duravant.com](http://www.duravant.com)

ARPAK | FISCHBEIN INTERNATIONAL | FMH CONVEYORS | HAMER-FISCHBEIN | KEY TECHNOLOGY | MARLEN INTERNATIONAL | MESPACK | OHLSON | QC CONVEYORS